

MCS-SR OCC

EasySens Motion sensor

thermokon[®]
HOME OF SENSOR TECHNOLOGY

Datasheet

Subject to technical alteration
Issue date: 01.01.2024 • A124

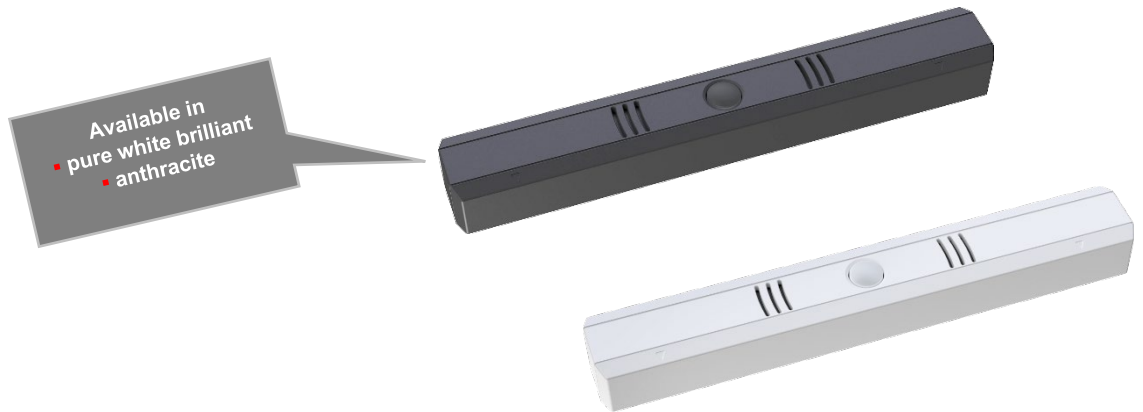

» APPLICATION

EasySens-radio-motion detector for person movement detection indoors - or in office spaces. The data transfer takes place via EnOcean-standard radio telegrams to the receiver.

The device has the following functions

- Movement detection 360°
- Wireless radio transmission

» TYPES AVAILABLE

EasySens Motion sensor

MCS-SR Occ (battery powered)

Available in pure white, anthracite (varnished)

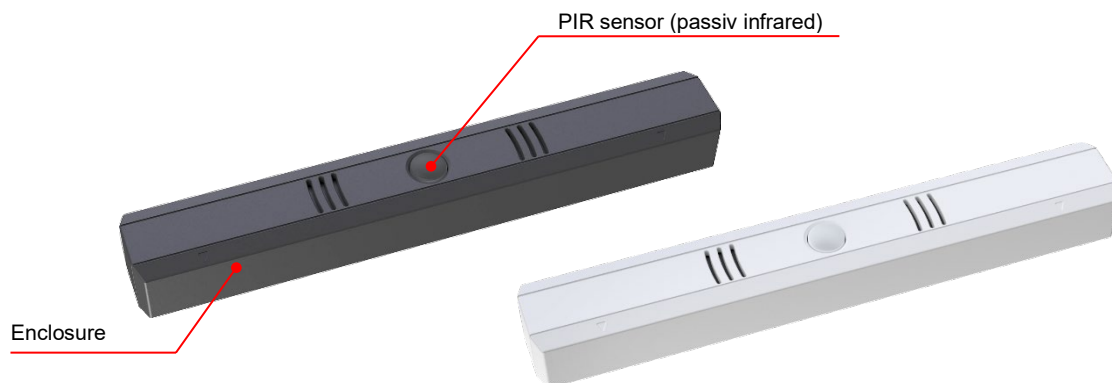

» SECURITY ADVICE – CAUTION



The installation and assembly of the device should only be performed by authorized personnel.

The product should only be used for the intended application. Unauthorised modifications are prohibited! The product must not be used in relation with any equipment that in case of a failure may threaten, directly or indirectly, human health or life or result in danger to human beings, animals or assets. Ensure all power is disconnected before installing. Do not connect to live/operating equipment.

Please comply with:

- Local laws, health & safety regulations, technical standards and regulations
- Condition of the device at the time of installation, to ensure safe installation
- This data sheet and installation manual

» PRODUCT TESTING AND CERTIFICATION



Declaration of conformity

The declaration of conformity of the products can be found on our website <https://www.thermokon.de/>

» NOTES ON DISPOSAL



As a component of a large-scale fixed installation, Thermokon products are intended to be used permanently as part of a building or a structure at a pre-defined and dedicated location, hence the Waste Electrical and Electronic Act (WEEE) is not applicable. However, most of the products may contain valuable materials that should be recycled and not disposed of as domestic waste. Please note the relevant regulations for local disposal.

» INFORMATION ABOUT EASYSSENS® (RADIO) / AIRCONFIG GENERAL USAGE



EasySens® - airConfig

Basic information about EasySens® radio and about general usage of our airConfig software, please download from our website.

» OVERVIEW OF THE RADIO TELEGRAMS



EEP

The structure of the data contained in the telegram can be found in the EEP (EnOcean equipment profile) list provided by the EnOcean Alliance.

» TECHNICAL DATA

Radio technology	EnOcean (IEC 14543-3-10), transmission power <10 mW (EEP A5-07-01)
Frequency	902 MHz
Antenna	internal transmitting/receiving antenna
Power supply	battery operated, 1x Alkali-Mangan AAA (included in delivery)
Sending interval	immediately at the first motion detection, then every 5 min at presence, no presence at 5 min., Heartbeat at no presence: 20 min.
Detection range	Ø=16 ft. (5 m) at a mounting height of 8 ft. (2,5 m)
Sensor	PIR (passive infrared)
Enclosure	PC V0, pure white or anthracite (optional)
Protection	IP20 according to DIN EN 60529
Ambient condition	-4..+ 140 °F, max. 85% rH non-condensing
Mounting	to be mounted flat onto the surface using adhesive foil (already mounted on bottom cover) or screws

» FUNCTIONAL DESCRIPTION

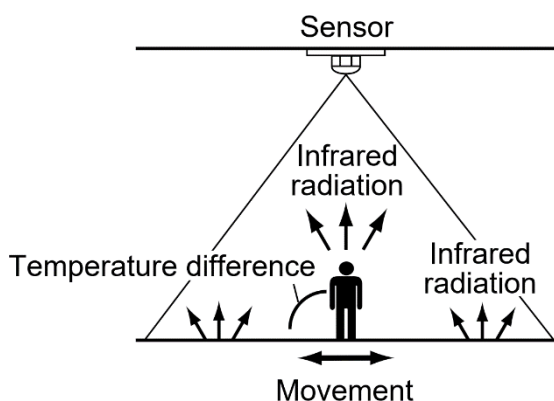

This sensor detects changes in infrared radiation that occur when a person (or object) whose temperature differs from the environment moves.

The specified ranges refer to average conditions at a certain mounting height and are approximate values. The motion detector should not be mounted near disturbing heat sources (e.g. lamps, radiators, fans etc.) to avoid false alarms. The range can vary with changing temperature conditions.

Objekt properties:	
temperature difference (objekt and environment)	at least. 39 °F
speed	At least 1 to 2 ft./s
Size	27,5 x 9,8 in.

» **COMMISSIONING**

Before mounting, the device check the radio reception area. The radio signal needs to be sufficient for the receiver. The device can be mounted via the adhesive tape already mounted, or optionally with screws

» **Device Opening**

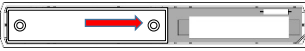
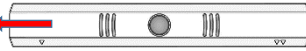
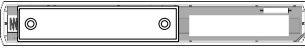
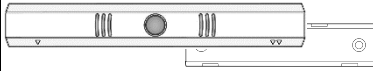
Bottom View	Top View
 <p>Push bottom cover laterally.</p>	 <p>Move device laterally to the left (observe arrow symbol orientation!)</p>
 <p>Remove cover</p>	 <p>Remove top section</p>

» **Battery installation**

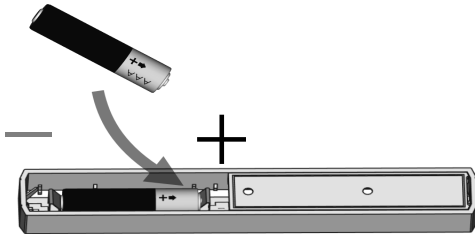

Insert the button cell in the mounting bracket.
Pay attention to button cell polarity!

» **TEACH-IN**

By default, a 1BS teach-in telegram is transmitted by pressing the Learn button (opened device). Press the key on the back to trigger a teach-in telegram. The teach-in telegram identifies the device manufacturer, the function and the type of the device.

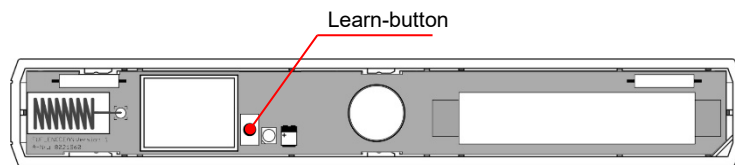

» **DETECTION RANGE**

Detection range	
Detection distance	max. 23 ft.
Field of view horizontal x	90
Field of view vertical y	90
Detection zones	32

A installation height of 8 ft. results in a detection area of approx. 16 x 16 ft., divided into 32 measuring zones.

Formel: $\tan(55) \cdot \text{installation height} = \text{radius detection range } x$

Formel: $\tan(46,5) \cdot \text{Installation height} = \text{radius detection range } y$

Functional test

Check the movement detection function by walking through the detection area of the sensor. Review if the radio telegram was send by the MCS-SR Occ

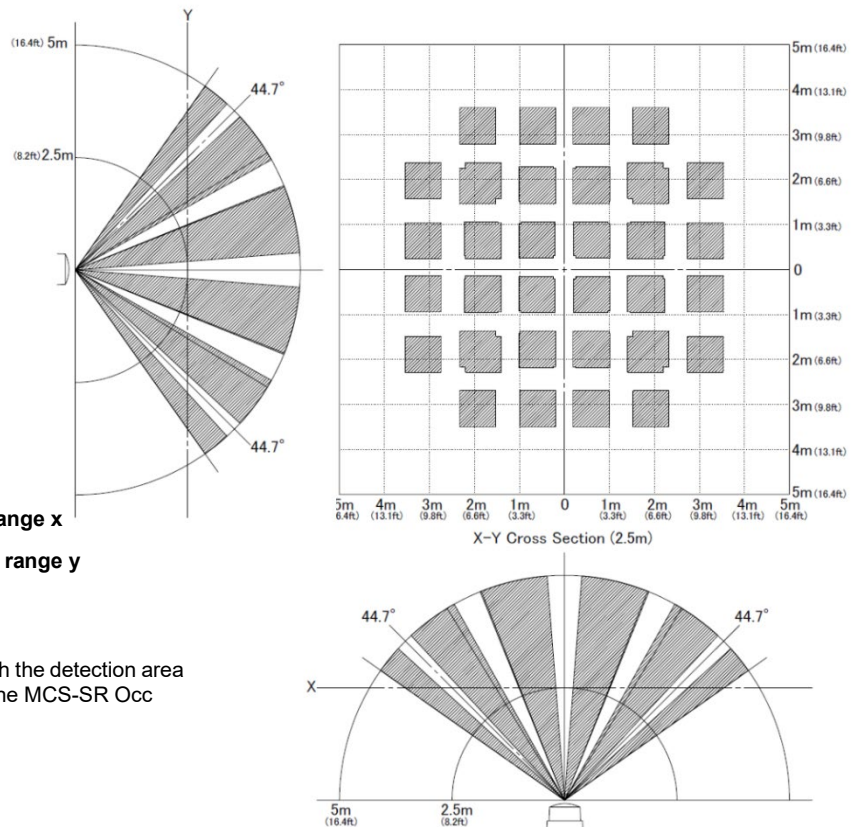

» **ENERGY STATUS (SIGNAL TELEGRAM)**

An energy status message (signal telegram) is sent at 6-hour intervals.

Signal telegrams (SIG) can be received with an STC65+ Modbus (from V4.5.0)STC-Bacnet IP (from V3.0.3.4) or a STC-IoT Gateway and evaluated by the superior control unit (BMS).

Telegram content

Offset	Size	Data	Shortcut	Description	
0	8	Message index	MID	Enumeration: 0x06 – Energy status of the device	
8	8	Energy	ERG	Description	Telegram (SIG)
				0..100 %	
				100: Energy level good	hex(06 64)
				1: Energy level low	hex(06 01)
0: Energy level critical	hex(06 00)				

» **DIMENSIONS (MM)**

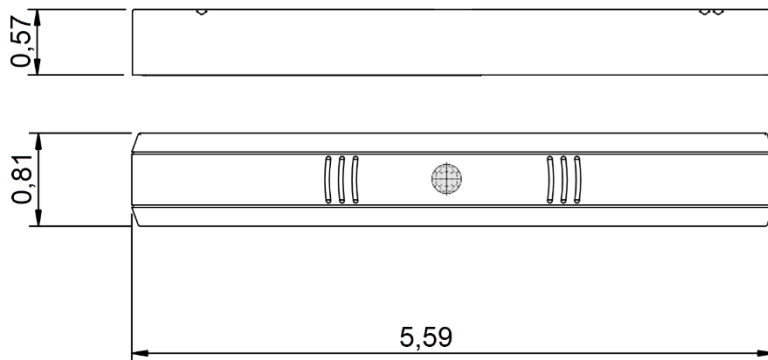

» **ACCESSORIES (OPTIONAL)**

Battery 1,5V AAA (Micro)

Item No. 739351