

# thanos EVO RS485 Modbus Casambi

Room operating unit temperature, optional with humidity | CO2 | VOC

**thermokon**<sup>®</sup>  
HOME OF SENSOR TECHNOLOGY

## Datasheet

Subject to technical alteration  
Issue date: 05.02.2024 • A131

thanos **EVO**



**CASAMBI**



## » APPLICATION

Room control unit with RS485 Modbus and Casambi radio interface for intuitive lighting control of Casambi ecosystem participants with up to four integrated sensors for recording room temperature, humidity, CO2 and VOC. A 4.8" touch screen is used to start scenes, select colors, switch lights or over Modbus control shading and climate functions. A monitoring function visualizes the measured values of the integrated sensors in color. The simple configuration via the Casambi app allows device-specific settings or the configuration of scenes and lighting functions with Casambi radio.

## » TYPES AVAILABLE

**Touch screen room operating unit temperature + opt. humidity, CO2, VOC – active BUS**

- thanos EVO Temp RS485 Modbus Casambi\*
- thanos EVO Temp\_rH RS485 Modbus Casambi\*
- thanos EVO CO2 Temp\_rH RS485 Modbus Casambi\*
- thanos EVO VOC Temp\_rH RS485 Modbus Casambi\*
- thanos EVO CO2+VOC Temp\_rH RS485 Modbus Casambi\*

*\* also available as design variant*

## » SECURITY ADVICE – CAUTION

The installation and assembly of electrical equipment should only be performed by authorized personnel.



The product should only be used for the intended application. Unauthorised modifications are prohibited! The product must not be used in relation with any equipment that in case of a failure may threaten, directly or indirectly, human health or life or result in danger to human beings, animals or assets. Ensure all power is disconnected before installing. Do not connect to live/operating equipment.

Please comply with

- Local laws, health & safety regulations, technical standards and regulations
- Condition of the device at the time of installation, to ensure safe installation
- This data sheet and installation manual

## » PRODUCT TESTING AND CERTIFICATION



### Declaration of conformity

The declaration of conformity of the products can be found on our website  
<https://www.thermokon.de/direct/en-gb/categories/thanos-evo>

## » MOUNTING ADVISE ROOM SENSORS

The Accuracy of the room sensors are influenced by the technical specifications as well as the positioning and the installation type.

### During Assembly:

- Seal mounting box (if present).
- Installation type, air draught, heat source, radiation heat or direct sunlight can affect the measurement.
- Bulding material specific properties of the installation place (*brick-, concrete-, partition wall, cavity wall, ...*) can affect the measurement. (*e.g.: Concrete accepts room temperature variation slower than cavity walls*)

### Assembly not recommendet in...

- Air draught (e.g.: close to windows / doors / fans ...)
- Near heating sources,
- Direct sunlight
- Niches / between furniture / ...

## » BUILD-UP OF SELF-HEATING BY ELECTRICAL DISSIPATIVE POWER

Sensors with electronic components always have a dissipative power, which affects the temperature measurement of the ambient air. The dissipation in active temperature sensors shows a linear increase with rising operating voltage. This dissipative power has to be considered when measuring temperature. In case of a fixed operating voltage ( $\pm 0,2$  V) this is normally done by adding or reducing a constant offset value.

Thermokon transducers can be operated with variable operating voltages. The transducers are set at the factory with a reference operating voltage of 24 V =. At this voltage, the expected measuring error of the output signal will be the least. Other operating voltages, can cause a measurement deviation changing power loss of the sensor electronics.

A recalibration can be carried out directly on the unit or via a software variable (app or bus).

**Remark: Occurring draught leads to a better carrying-off of dissipative power at the sensor. Thus temporally limited fluctuations might occur upon temperature measurement.**

## » APPLICATION NOTICE FOR HUMIDITY SENSORS

At regular environmental condition, it is recommended to calibrate the sensor annually to check the compliance with the accuracy required in the application. The following conditions can damage the sensor element or lead in long term to loss of the specified accuracy:

- Mechanical stress
- Contamination (e.g. dust / fingerprints)
- Aggressive chemicals
- Ambient conditions (e.g. condensation on measuring element)



**Do not touch the sensor elements!**

**Re-calibration or exchange of the sensor element are not subject of the general warranty.**

## » INFORMATION ABOUT SELF-CALIBRATION FEATURE CO2

All gas sensors are subject to drift. The degree of drift is dependent on the use of components and product design. In addition, the following environmental conditions, among others, can accelerate/ favor the aging and wear of the sensors:

- Mechanical stress (also due to temperature fluctuation)
- Contamination (dust / fingerprints e.g.)
- Abrasive chemicals
- Environmental influences (high humidity / condensation on measuring element)

An internal self calibration function with dual channel technology compensates the caused drift. Thermokon sensors are for permanent use (e.g. hospitals).

## » INFORMATION ABOUT INDOOR AIR QUALITY CO2

EN 13779 defines several classes for indoor air quality:

Category	CO <sub>2</sub> content above the content in outdoor air in ppm		Description
	Typical range	Standard value	
IDA1	<400 ppm	350 ppm	Good indoor air quality
IDA2	400.. 600 ppm	500 ppm	Standard indoor air quality
IDA3	600..1.000 ppm	800 ppm	Moderate indoor air quality
IDA4	>1.000 ppm	1.200 ppm	Poor indoor air quality

## » APPLICATION NOTICE FOR AIR QUALITY SENSORS VOC

Volatile organic compounds (VOC) are gaseous and vaporous substances of organic origin in the air. VOC-sensors monitor the significant part of humanly olfactory sensed air quality. (e.g. body odor | tobacco smoke | odor of materials, furniture, carpets, paint, adhesives, ...)

**The VOC-Value is an application-specific indication for air quality and doesn't provide any information about individual components of VOC**

A VOC sensor oxidises the organic molecules that collide with it, which results in changing the resistance of the semiconductor.

**Any contact with the sensitive sensors must be avoided and will invalidate the warranty.**

The VOC Sensor is factory calibrated and can be calibrated via NOVOSapp subsequently, if needed.

## » TECHNICAL DATA

Measuring values	temperature, optional humidity   CO2   VOC
Network technology	RS485 Modbus, RTU, half-duplex, Baud rate 4800 9600 14400 19200 38400 56000 57600 or 115200 Parity: none (2 stopbits), even or odd (1 stopbit), <b>Fail-safe Biasing required</b>
	Casambi (Evolution) 2,4 GHz
Power supply	24 V = ( $\pm 10\%$ ) or 24 V ~ ( $\pm 10\%$ ) SELV <i>With alternating voltage, the correct polarity must be ensured.<sup>1</sup></i>
Power consumption	typ. 2,5 W (24 V =)   5 VA (24 V ~) <sup>2</sup>
Measuring range temp	-50..+50 °C   0..+50 °C   -15..+35   -20..+80 °C, Standardeinstellung: 0..+50 °C, optional parametrierbar über Thermokon NOVOSapp oder BUS
Accuracy temperature	$\pm 0,5K$ (typ. at 21 °C)
Inputs	1x input for floating contact
Control functions Modbus	occupancy signalling, blinds UP/DOWN/SET, setup scenarios, fan stages, setpoint, ECO function, measured value display & history
Casambi functions	light ON/OFF/DIM, colour temperature, colour control RGBW, setup scenarios
Display	TFT 4,8", 1120x480 px, capacitive touch technology
Enclosure	PC V0 and glass, Surface glass, white or black   design variant glas + aluminium
Protection	IP30 according to DIN EN 60529
Cable entry	rear entry, breaking points bottom, drill mark top
Connection electrical	tool-free mountable spring terminal, max. 1,5 mm <sup>2</sup>
Ambient condition	0..+50 °C, max. 85% non-condensing
Mounting	surface mounted on flush-mounting box ( $\varnothing=60$ mm) or to be mounted flat onto the surface using screws, base part can be mounted and wired separately

<sup>1</sup> When several BUS devices are supplied by one 24 V AC voltage supply, it is to be ensured that all "positive" operating voltage input terminals (+) of the field devices are connected and all "negative" operating voltage input terminals (-) (=reference potential) are connected (in-phase connection of field devices). In the case of reversed polarity at one field device, a supply voltage short-circuit would be caused by that device.

**The short-circuit current thus flowing through this field device will damage it. Therefore, pay attention to the correct wiring.**

<sup>2</sup> type inrush current: 2A (< 5 ms)

### » Humidity (optional)

Measuring range humidity (optional configurable)	<b>relative humidity</b> (default) 0..100% rH	<b>Enthalpy</b> 0..85 KJ/kg	<b>absolute humidity</b> 0..50   0..80 g/m <sup>3</sup>	<b>dew point</b> 0..+50   -20..+80 °C
	configurable via Thermokon NOVOSapp or BUS			
Accuracy humidity	$\pm 2\%$ between 10..90% rH (typ. at 21 °C)			

### » CO2 (optional)

Measuring range CO2	0..2000   0..5000 ppm (configurable via Thermokon NOVOSapp or BUS)
Accuracy CO2	$\pm 50$ ppm +3 % of reading, (typ. at 21 °C, 50% rH, 1015 hPa)
Calibration	self-calibration dual channel
Sensor	NDIR (non-dispersive, infrared)

### » VOC (optional)

Measuring range VOC	0..100 %
Sensor	VOC sensor (heated metal oxide semiconductor)

» CONNECTION PLAN

Room operating unit

thanos EVO RS485 Modbus Casambi

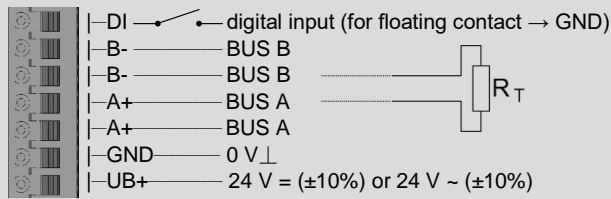

With alternating voltage, the correct polarity must be ensured! Please note the technical data.

Don't forget the BUS termination (120 Ω) at the last device of the line! (Not included in delivery)

» MOUNTING ADVICES

Cable entry

There are predetermined breaking points for 2 optional cable entries on the underside of the base plate.

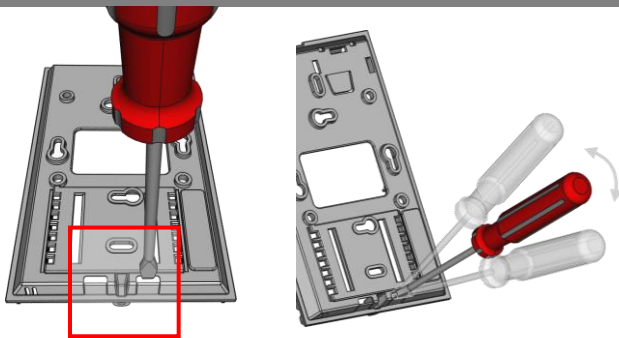

Please make sure that the device is de-energized if you want to install it!

The installation can be performed on the flat wall surface or on a flush-mounted box. A representative place should be selected. Sunshine and draft, e.g. in the installation tube should be avoided, so that the measurement result is not falsified. Seal the end of the installation tube.

- For wiring, the upper part of the device must be removed from the base plate. Base plate and upper part are detachably connected to each other by means of locking lugs.
- The mounting of the base plate on the flat wall surface is done with rawplugs and screws.
- Finally, the device is attached to the base plate and fixed with the screw.

Housing open / close

Snap the upper part of the housing into the locking lug on the upper side

Fix the upper part of the housing on the underside with the screw

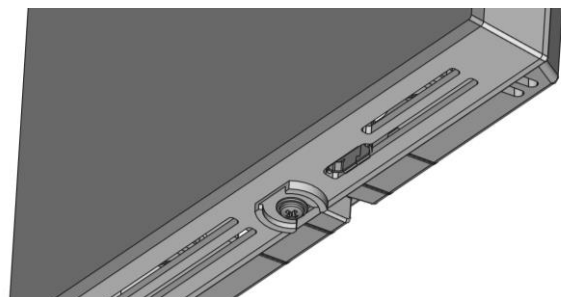
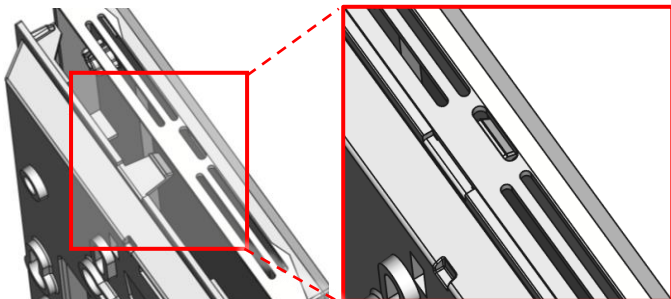

» NOTES ON DISPOSAL



The crossed-out wheeled bin symbol indicates that the product or removable batteries must not be disposed of with household or commercial waste. Within the EU, you are legally obliged to dispose of the product separately and appropriately in accordance with the national laws of your country. Alternatively, please contact your supplier or Thermokon Sensortechnik GmbH. Further information can be found at: [www.thermokon.com](http://www.thermokon.com)

» **FUNCTION DESCRIPTION – HOMESCREEN THANOS EVO**

**Homescreen**  
 The display on the main screen of the thanos EVO room control unit can be freely parameterised. All icons and notifications can be switched on and off. Set point can also be overwritten.

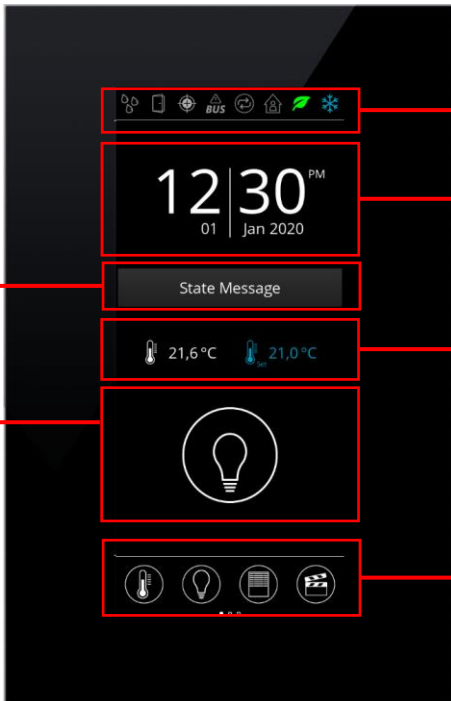

**Headline**  
 In the header of the main screen various icons can be shown or hidden as desired.

**Date / time**  
 The time and date are in the center of the main screen.

**Setpoint / room temperature**  
 The currently set target value of the room control unit and the room temperature are shown on the display.

**Navigation bar**  
 The navigation bar is a central element on the Home screen. It contains all menus such as climate, light, blinds, scene, monitoring, display ON/OFF and settings. If certain menus are not needed, they can be switched off as desired. With a swipe gesture you can scroll between the menu pages in the navigation bar.



To reduce the risk of burnt-in effects of the screen contents, it is recommended to activate the screen saver. By default, the screen saver switches on 120 seconds after the last interaction.

**Status messages**  
 At any time, any text message (max. 24 characters) can be displayed on the main screen for status reporting or notification.

**Favorites button**  
 Light, blind circles or complete submenu can be placed on the home screen as a favourites button that is quickly accessible. Up to 4 favourite buttons are possible.

*Example below: 4 different Light circles*

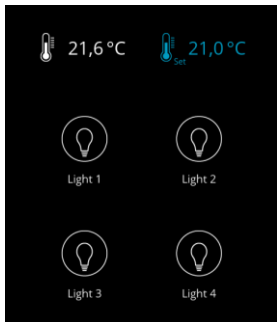



**Modbus addresses:**

NOVOS-RS485 Modbus Interface

A detailed description of the Modbus addresses can be found under the following link: → [Download](#)

» CONFIGURATION

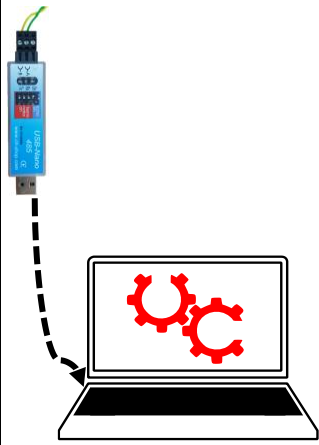
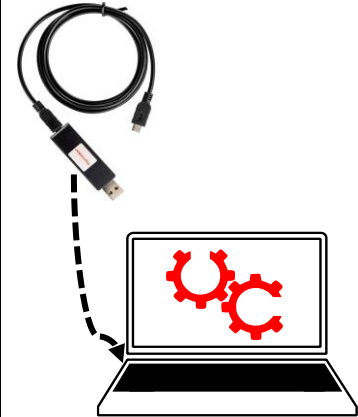
The configuration is performed in powered state. The following options are available for configuring the device:

Device connection	RS485	Micro-USB	Casambi Communication
Configuration-adapter	<p>USB-RS485 Converter</p> 	<p>Thermokon USB-Interface</p> 	<p>internal</p> 
Configurations-software	<p>PC/Notebook with uConfig software                      Parameterization with Thermokon software uConfig, via USB/RS485 Converter*                      (Art.-No.: 668293)</p>	<p>PC/Notebook with uConfig software                      Partly parameterization with Thermokon software uConfig, via Micro RS-232/USB Converter*                      (Art.-No.: 597838)</p>	<p>Smartphone/Tablet with CASAMBI App                      Parameterization with mobile device via bluetooth and CASAMBI App.</p>

\*Commercially available Bluetooth dongles or USB to Micro-USB adapter cables are not compatible. You need a mobile device that supports at least Bluetooth version 4.1. The configuration app with the corresponding instructions can be downloaded from the Google Play Store or the Apple App Store.

Additionally a configuration via RS485 interface via BMS during powered state is possible.

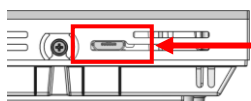

Position of the micro USB port, see bottom of the device, for configuration with Bluetooth dongle or Micro-USB programming interface

» CASAMBI COMMUNICATION

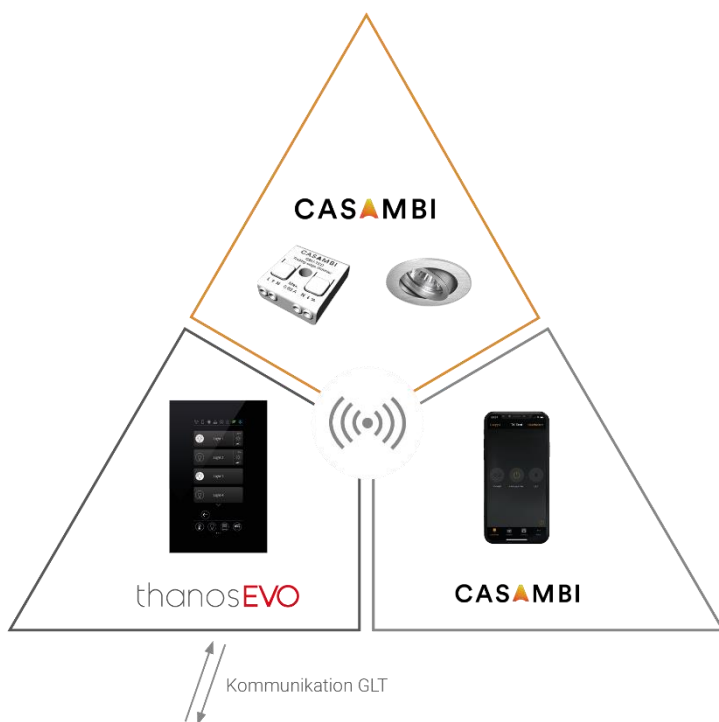

**A thanos EVO Casambi serves as an interface between a Building Management System and a coupled Casambi network.**

All information received from the thanos EVO via Casambi is passed on to the BMS, so that the current status can be viewed and used in the building control system at any time.

**Commands for Casambi functions sent to thanos EVO via bus communication are sent to the Casambi network via Casambi radio.**

» CASAMBI COMISSIONING

1. Connect the device to the power supply. Observe the connection diagram!
2. Open Casambi App (iOS App Store / Android Play Store)  
*If an unpaired device is found, it is suggested to add the device to a network.*
3. Add thanos EVO to an existing Casambi network, is required switch to other Casambi network first.  
*After pressing the "back" button the network can be changed ("my networks").*
4. The device appears in the gateway section.
5. Configure the thanos Evo Casambi parameters.

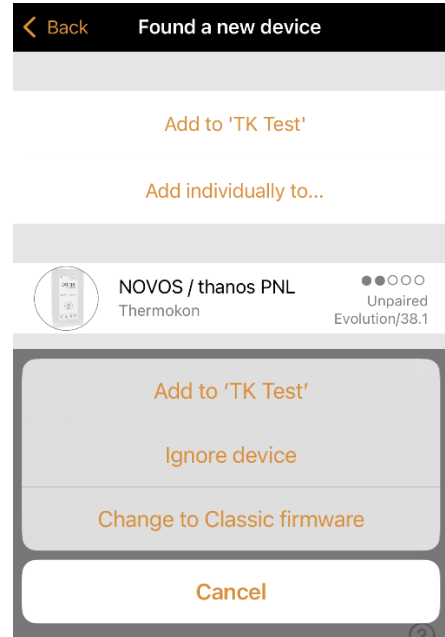

» CASAMBI PARAMETER

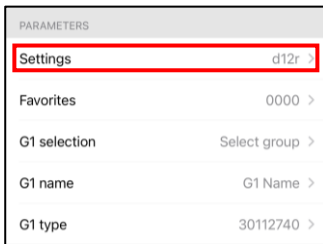

Settings (parameter LTBC)

- L = language**  
D – german  
E – english  
X – no change
- T = Time synch**  
0 – no time synch  
1 – time synch from Casambi to device
- B = Behavior**  
1 – external control (configurable via BUS)  
2 – standalone/panel (configurable only via CASAMBI)
- C = display color scheme**  
x background color / text color  
0 no change
- B** black / white  
**W** white / black
- G** green / white  
**L** blue / white
- R** red / white

Example settings: d12l = german | time synch | standalone/panel | background color blue / text color white

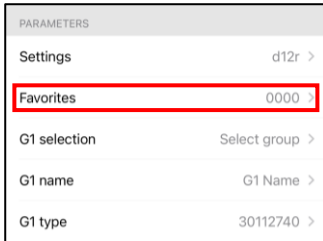

Favorites\* (ABCDE)

- A favorite button 1
- B favorite button 2
- C favorite button 3
- D favorite button 4
- E favorite button 5
- Default value: 0 - none
- i.E.: 0b300
- none / scene 2 / group 3

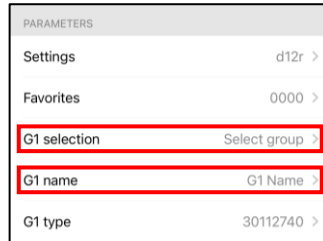

Gx selection / name (Selection / Input field)

- Selection** – Casambi group
- Name** – group name

Favorites

1	Group 1	a	Scene 1	i	Presence	q	shading 1
2	Group 2	b	Scene 2	j	Eco	r	shading 2
3	Group 3	c	Scene 3	k	Climate menu	s	shading 3
4	Group 4	d	Scene 4	l	Lighting menu	t	shading 4
5	Group 5	e	Scene 5	m	Blind menu	u	shading 5
6	Group 6	f	Scene 6	n	Scene menu	v	shading 6
7	Group 7	g	Scene 7	o	Monitoring menu	w	shading 7
8	Group 8	h	Scene 8	p	fan menu (Novos 7)	x	shading 8

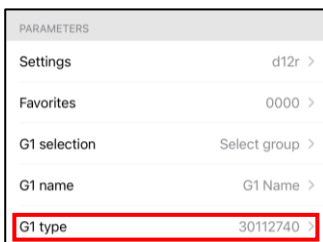

Gx type (Light group configuration)

- ITDSMnMx
- I – Icon
- T – Type
- D – Dim function
- S – Step size
- Mn / Mx – minimum / maximum Color temperature

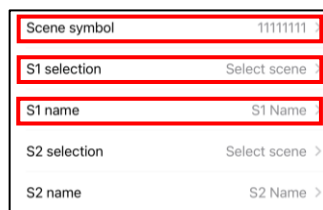

Scene symbol (Scene symbol configuration)\*

- 1. digit = scene symbol 1
- 2. digit = scene symbol 2...

Sx selection / name (Selection / Input field)

- Selection** – scene
- Name** – scene name

**Gx Type parameter listing**

I	0 – universal, 1 – spot, 2 – cassette, 3 – floor lamp (default)
T	0 – slider (default), 1 – RGBW colourpicker, 2 – colour temperature picker
D	0 – not dimmable, 1 – dimmable (default)
S	0 – 1, 1 – 1 (default), 2 – 2, 3 – 3, 4 – 4, 5 – 5, 6 – 10, 7 – 15, 8 – 20 (in %)
Mn	Input value (2 digits) multiplied with 100 = minimum kelvin (Color Temperature) (i.E.: Mn = 27 -> CTmin = 27 * 100 = 2700K (default))
Mx	Input value (2 digits) multiplied with 100 = maximum kelvin (Color Temperature) (i.E.: Mx = 40 -> CTmax = 40 * 100 = 4000K (default))

Example Gx Type: 30112740 = floor lamp | slider | dimmable | 1 | min kelvin color temp 2700k | max kelvin color temp 4000k

**Scenen symbol parameter listing**

0	work (briefcase)
1	presentation (canvas)
2	cinema (screen)
3	party (cocktail glass)
4	bedroom (bed)
5	food (serving bell)
6	do not disturb (lock)
7	cleaning (vaccum cleaner)
8	scene (clapperboard)

Example scene symbol: 02437000 = scene 1: work | scene 2: cinema | scene 3: bedroom | scene 4: party | scene 5: cleaning

**» DIMENSIONS (MM)**

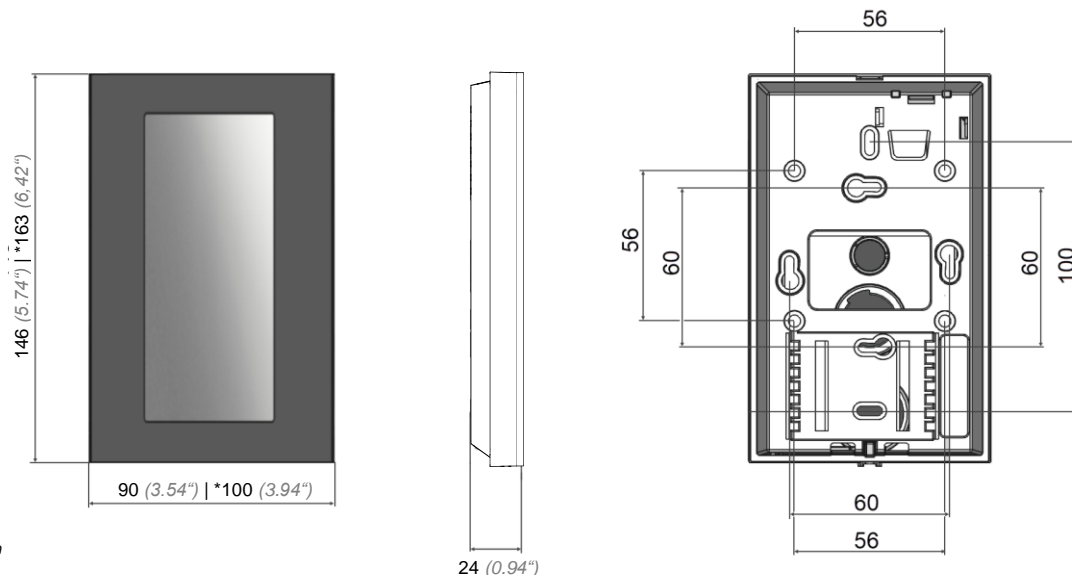

\* Thanos Evo Design  
Dimensions

**» ACCESSORIES (OPTIONAL)**

Rawplugs and screws (2 pcs. each)  
PSU-UP24 – flush mount power supply 24 V (AC Input: 100..240 V ~ | DC Output 24 V = 0,5 A)

Item No. 102209  
Item No. 645737

Thermokon USB-Interface  
USB RS485 Modbus RTU Logger  
USB Interface RS485 (incl. driver CD)  
RS485 Biasing Adapter

Item No. 597838  
Item No. 809917  
Item No. 668293  
Item No. 811378