

NOVOS Touch KNX

Room operating unit temperature, optional with humidity | CO2 | VOC

thermokon[®]
HOME OF SENSOR TECHNOLOGY

Datasheet

Subject to technical alteration
Issue date: 03.04.2024 • A140



» APPLICATION

Room control unit with room temperature measurement, optional humidity, CO2, or VOC and a monitoring function for colourful visualization of the measured values. The maintenance-free sensor creates the conditions for a pleasant indoor climate and well-being. Typical applications are schools, office buildings, hotels or cinemas. The room control unit has a high-resolution 4.8" display with a noble glass surface and has to be mounted in a flush-mounted box. The innovative and self-explanatory operation offers the functions of light, shading, climate and scene control for intelligent room automation.

» TYPES AVAILABLE

Touch screen room operating unit temperature + opt. humidity, CO2, VOC – active BUS

- thanos EVO Temp KNX
- thanos EVO Temp_rH KNX
- thanos EVO CO2 Temp_rH KNX
- thanos EVO VOC Temp_rH KNX
- thanos EVO CO2+VOC Temp_rH KNX

available in the colours white and black

» SECURITY ADVICE – CAUTION

The installation and assembly of electrical equipment should only be performed by authorized personnel.



The product should only be used for the intended application. Unauthorised modifications are prohibited! The product must not be used in relation with any equipment that in case of a failure may threaten, directly or indirectly, human health or life or result in danger to human beings, animals or assets. Ensure all power is disconnected before installing. Do not connect to live/operating equipment.

Please comply with

- Local laws, health & safety regulations, technical standards and regulations
- Condition of the device at the time of installation, to ensure safe installation
- This data sheet and installation manual

» NOTES ON DISPOSAL



The crossed-out wheelee bin symbol indicates that the product or removable batteries must not be disposed of with household or commercial waste. Within the EU, you are legally obliged to dispose of the product separately and appropriately in accordance with the national laws of your country. Alternatively, please contact your supplier or Thermokon Sensortechnik GmbH. Further information can be found at: www.thermokon.com

» MOUNTING ADVISE ROOM SENSORS

The Accuracy of the room sensors are influenced by the technical specifications as well as the positioning and the installation type.

During Assembly:

- Seal mounting box (if present).
- Installation type, air draught, heat source, radiation heat or direct sunlight can affect the measurement.
- Bulding material specific properties of the installation place (*brick-, concrete-, partition wall, cavity wall, ...*) can affect the measurement.

Assembly not recommendet in...

- Air draught (e.g.: close to windows / doors / fans ...)
- Near heating sources,
- Direct sunlight
- Niches / between furniture / ...

» BUILD-UP OF SELF-HEATING BY ELECTRICAL DISSIPATIVE POWER

Sensors with electronic components always have a dissipative power, which affects the temperature measurement of the ambient air. The dissipation in active temperature sensors shows a linear increase with rising operating voltage. This dissipative power has to be considered when measuring temperature. In case of a fixed operating voltage ($\pm 0,2$ V) this is normally done by adding or reducing a constant offset value.

Thermokon transducers can be operated with variable operating voltages. The transducers are set at the factory with a reference operating voltage of 24 V =.

At this voltage, the expected measuring error of the output signal will be the least. Other operating voltages, can cause a measurement deviation changing power loss of the sensor electronics.

A recalibration can be carried out directly on the unit or via a software variable (app or bus).

Remark: Occurring draught leads to a better carrying-off of dissipative power at the sensor. Thus temporally limited fluctuations might occur upon temperature measurement.

» APPLICATION NOTICE FOR HUMIDITY SENSORS

At regular environmental condition, it is recommended to calibrate the sensor annually to check the compliance with the accuracy required in the application. The following conditions can damage the sensor element or lead in long term to loss of the specified accuracy:

- Mechanical stress
- Contamination (e.g. dust / fingerprints)
- Aggressive chemicals
- Ambient conditions (e.g. condensation on measuring element)



Do not touch the sensor elements!

Re-calibration or exchange of the sensor element are not subject of the general warranty.

» INFORMATION ABOUT SELF-CALIBRATION FEATURE CO2

All gas sensors are subject to drift. The degree of drift is dependent on the use of components and product design. In addition, the following environmental conditions, among others, can accelerate/ favor the aging and wear of the sensors:

- Mechanical stress (also due to temperature fluctuation)
- Contamination (dust / fingerprints e.g.)
- Abrasive chemicals
- Environmental influences (high humidity / condensation on measuring element)

An internal self calibration function with dual channel technology compensates the caused drift. Thermokon sensors are for permanent use (e.g. hospitals).

» INFORMATION ABOUT INDOOR AIR QUALITY CO2

EN 13779 defines several classes for indoor air quality:

Category	CO2 content above the content in outdoor air in ppm		Description
	Typical range	Standard value	
IDA1	<400 ppm	350 ppm	Good indoor air quality
IDA2	400.. 600 ppm	500 ppm	Standard indoor air quality
IDA3	600..1.000 ppm	800 ppm	Moderate indoor air quality
IDA4	>1.000 ppm	1.200 ppm	Poor indoor air quality

» APPLICATION NOTICE FOR AIR QUALITY SENSORS VOC

Volatile organic compounds (VOC) are gaseous and vaporous substances of organic origin in the air. VOC-sensors monitor the significant part of humanly olfactory sensed air quality. (e.g. body odour | tobacco smoke | odour of materials, furniture, carpets, paint, adhesives, ...)

The VOC-Value is an application-specific indication for air quality and doesn't provide any information about individual components of VOC

A VOC sensor oxidises the organic molecules that collide with it, which results in changing the resistance of the semiconductor.

Any contact with the sensitive sensors must be avoided and will invalidate the warranty.

The VOC Sensor is factory calibrated and can be calibrated via NOVOSapp subsequently, if needed.

» PRODUCT TESTING AND CERTIFICATION



Declaration of conformity

The declaration of conformity of the products are available on our website
<https://www.thermokon.de/direct/en-gb/categories/novos-touch>

» TECHNICAL DATA

Measuring values	temperature, optional humidity CO2 VOC
Network technology	KNX (TP1)
Power supply	24 V = ($\pm 10\%$) SELV
Power consumption	typ. 2,5 W (24 V =)
Bus current consumption	3 mA
Measuring range temp	0..+50 °C
Accuracy temperature	$\pm 0,5K$ (typ. at 21 °C)
Inputs	3x input for floating contact or 2x input for floating contact + 1x input for external NTC10k)
Control functions	occupancy signalling, light ON/OFF/DIM, setup scenarios, blinds UP/DOWN/SET, fan stages, setpoint, ECO-Function, measured value RGB-LED indication /display & history .
Display	TFT 4,8", 1120x480 px, capacitive touch technology
Enclosure <i>(type dependent)</i>	PC V0, pure white, Design surface glass Enclosure: white or black, Design cover: glass white or black
Protection	IP30 according to DIN EN 60529
Cable entry	rear entry
Connection electrical	tool-free mountable spring terminal, max. \varnothing 0,8 mm
Ambient condition	0..+50 °C, max. 85% non-condensing
Mounting	surface mounted on flush-mounting box ($\varnothing=60$ mm) , base part can be mounted and wired separately

» Humidity *(optional)*

Measuring range humidity <i>(optional configurable)</i>	relative humidity (default) 0..100% rH	Enthalpy 0..85 KJ/kg	absolute humidity 0..50 0..80 g/m ³ ,	dew point 0..+50 -20..+80 °C,
	configurable via Thermokon NOVOSapp or BUS			
Accuracy humidity	$\pm 2\%$ between 10..90% rH (typ. at 21 °C)			

» CO2 *(optional)*

Measuring range CO2	0..2000 0..5000 ppm (configurable via ETS or Thermokon NOVOSapp)
Accuracy CO2	$\pm(50$ ppm +3 % of reading), (typ. at 21 °C, 50% rH, 1015 hPa)
Calibration	self-calibration dual channel
Sensor	NDIR (non-dispersive, infrared)

» VOC *(optional)*

Measuring range VOC	0..100 %
Calibration	self-calibration
Sensor	VOC sensor (heated metal oxide semiconductor)

» CONFIGURATION AND COMMISSIONING

The functional description of the device, as well as the KNX Interface description is documented in the KNX manual.



KNX Manual:

The KNX manual is found on our website <https://www.thermokon.de/download>

» CONNECTION PLAN

Room operating unit – active KNX

The power supply and the bus line are connected via socket terminals on the rear of the device.

When the programming button is pressed, the device is switched to programming mode and the programming LED starts lighting.

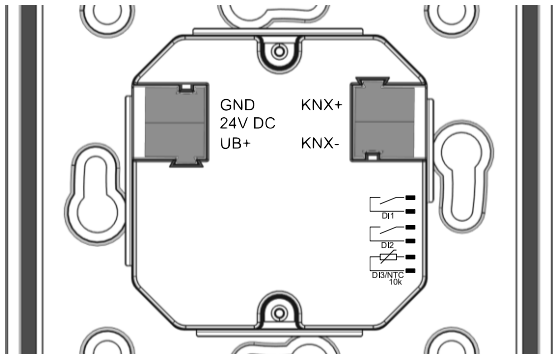

On the side of the lower part of the housing there is a socket connector for connecting up to 3 digital inputs (optional as an NTC10k). The connection is made via a pre-assembled female connector (included in delivery).

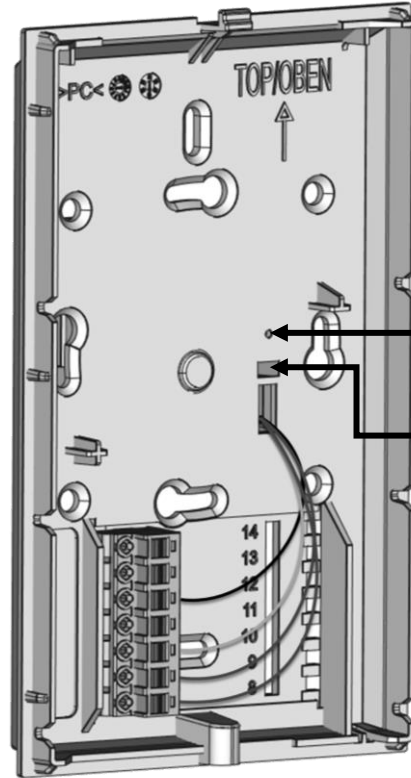
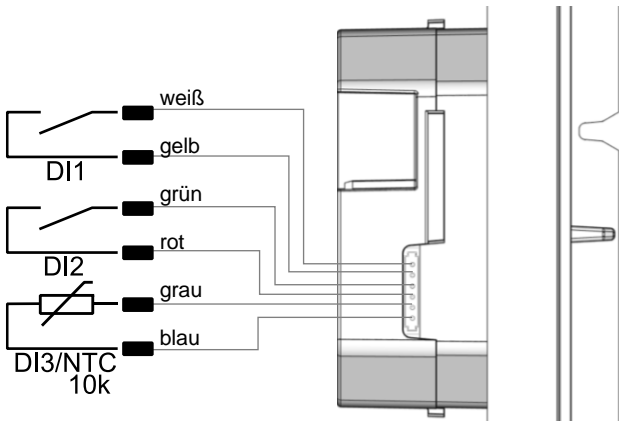

Programming LED
Programming button

- 7= n.c.
- 6= n.c.
- 5= WH (white)
- 4= n.c.
- 3= YE (yellow)
- 2= BK (black)
- 1= RD (red)

» MOUNTING ADVICES

Please make sure that the device is de-energized if you want to install it!

The installation can be performed on a flush-mounted box. A representative place should be selected. Sunshine and draft, e.g. in the installation tube should be avoided, so that the measurement result is not falsified. Seal the end of the installation tube.

- For wiring, the upper part of the device must be removed from the base plate. Base plate and upper part are detachably connected to each other by means of locking lugs.
- The mounting of the base plate on the flat wall surface is done with rawplugs and screws.
- Finally, the device is attached to the base plate and fixed with the screw.

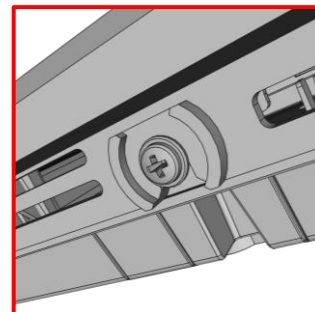
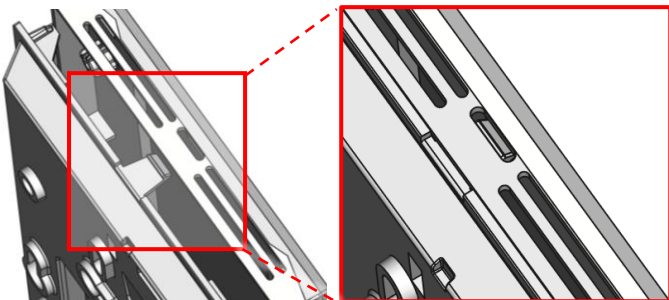

Snap the upper part of the housing into the locking lug on the upper side

Fix the upper part of the housing on the underside with the screw

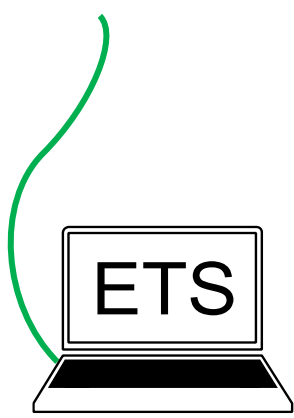
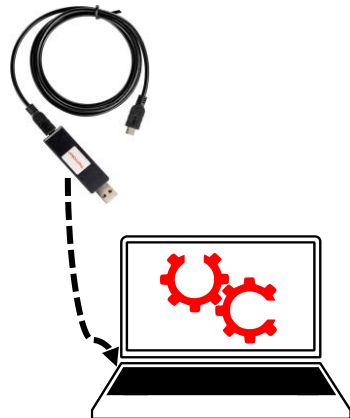

» CONFIGURATION

The Configuration is carried out in the powered state. The following options are available for configuration:

Connection to device	KNX TP1	Micro-USB	Micro-USB
Configuration-adapter	USB-interface KNX 	Thermokon USB-interface 	USB-bluetooth dongle 
Configuration-software	PC/Notebook with ETS software <i>Configuration via Desktop PC/Notebook with ETS software and USB-interface KNX</i>	PC/Notebook with uConfig software <i>Partly configuration with Thermokon software uConfig, via Thermokon USB-interface</i>	Smartphone/tablet with NOVOS app <i>Configuration with mobil device via bluetooth and NOVOSapp. Separat available bluetooth dongle* required.</i>

* Commercially available Bluetooth dongles or USB to Micro-USB adapter cables are not compatible. You need a mobile device that supports at least Bluetooth version 4.1. The configuration app with the corresponding instructions can be downloaded from the Google Play Store or the Apple App Store.

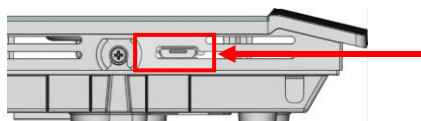

Position of the micro USB port, see bottom of the device, for configuration with Bluetooth dongle or Thermokon USB-interface

» DIMENSIONS IN MM (IN.)

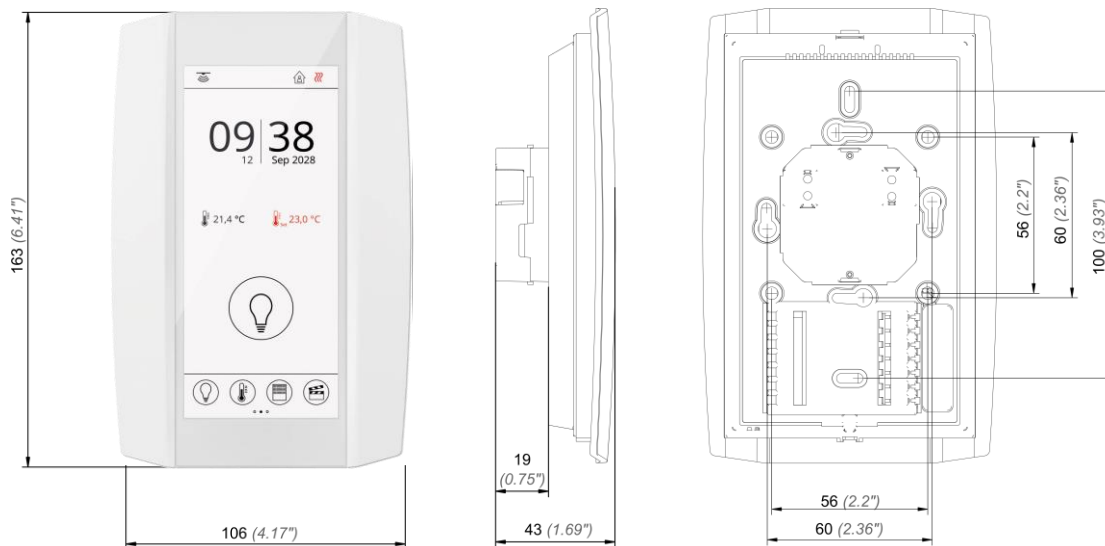

» ACCESSORIES (OPTIONAL)

Rawplugs and screws (2 pcs. each)
PSU-UP24 – flush mount power supply 24 V (AC Input: 100..240 V ~ | DC Output 24 V = 0,5 A)

Item No. 102209
Item No. 645737

Bluetooth dongle
Thermokon USB-Interface
USB-Interface KNX

Item No. 668262
Item No. 597838
Item No. 806190