

» WRF07 x (rH) RS485 BACnet MS/TP

Multifunction room operating panel

thermokon[®]
HOME OF SENSOR TECHNOLOGY

Datasheet

Subject to technical alteration
Issue date: 14.08.2020 • A110



» APPLICATION

The visually appealing flush-mounted room controller can be supplied in the most common switch ranges and various colour variants and serves for individual temperature control in living, hotel and office rooms. Possible operating elements are potentiometer, LEDs, buttons and rocker switch for set point adjustment, operating mode switching, presence detection and optical feedback. Depending on the type, continuous or 2-point valves for heating or cooling can be controlled. The removable terminal allows easy pre-wiring.

» TYPES AVAILABLE

WRF07 x RS485 Modbus

- Room operating unit temperature + humidity (optional) – DI4 RS485 Modbus
WRF07 x (rH) DI4
- Room controller temperature + humidity (optional) – AO2V RS485 Modbus
WRF07 x (rH) AO2V
- Room controller temperature + humidity (optional) – RS485 Modbus with flush mounted-IO module
WRF07 x (rH) DO2R
WRF07 x (rH) DO2T
WRF07 x (rH) OVR
WRF07 x (rH) OVT

optional operating elements

P = Potentiometer – Set point adjustment
T = Button – Occupancy
S = Rocker switch – Fan speed adjustment
FSx = Number of switching stages

» SECURITY ADVICE – CAUTION



The installation and assembly of electrical equipment should only be performed by authorized personnel.

The product should only be used for the intended application. Unauthorised modifications are prohibited! The product must not be used in relation with any equipment that in case of a failure may threaten, directly or indirectly, human health or life or result in danger to human beings, animals or assets. Ensure all power is disconnected before installing. Do not connect to live/operating equipment.

Please comply with

- Local laws, health & safety regulations, technical standards and regulations
- Condition of the device at the time of installation, to ensure safe installation
- This data sheet and installation manual

» NOTES ON DISPOSAL



As a component of a large-scale fixed installation, Thermokon products are intended to be used permanently as part of a building or a structure at a pre-defined and dedicated location, hence the Waste Electrical and Electronic Act (WEEE) is not applicable. However, most of the products may contain valuable materials that should be recycled and not disposed of as domestic waste. Please note the relevant regulations for local disposal.

» REMARKS TO ROOM SENSORS

Location and Accuracy of Room Sensors

The room sensor should be mounted in a suitable location for measuring accurate room temperature. The accuracy of the temperature measurement also depends directly on the temperature dynamics of the wall. It is important, that the back plate is completely flush to the wall so that the circulation of air occurs through the vents in the cover. Otherwise, deviations in temperature measurement will occur due to uncontrolled air circulation. Also the temperature sensor should not be covered by furniture or similar devices. Mounting next to doors (due to draught) or windows (due to colder outside wall) should be avoided.

The temperature dynamics of the wall will influence the temperature measurement. Various wall types (brick, concrete, dividing and hollow brickwork) all have different behaviours with regards to thermal variations.

Surface and Flush Mounting

The temperature dynamics of the wall influence the measurement result of the sensor. Various wall types (brick, concrete, dividing and hollow brickwork) have different behaviours with regard to thermal variations. A solid concrete wall responds to thermal fluctuations within a room in a much slower way than a light-weight structure wall. Room temperature sensors installed in flush boxes have a longer response time to thermal variations. In extreme cases they detect the radiant heat of the wall even if the air temperature in the room is lower for example. The quicker the dynamics of the wall (temperature acceptance of the wall) or the longer the selected inquiry interval of the temperature sensor is the smaller the deviations limited in time are.

» BUILD-UP OF SELF-HEATING BY ELECTRICAL DISSIPATIVE POWER

Temperature sensors with electronic components always have a dissipative power, which affects the temperature measurement of the ambient air. The dissipation in active temperature sensors shows a linear increase with rising operating voltage. This dissipative power has to be considered when measuring temperature. In case of a fixed operating voltage ($\pm 0,2$ V) this is normally done by adding or reducing a constant offset value. As Thermokon transducers work with a variable operating voltage, only one operating voltage can be taken into consideration, for reasons of production engineering. Transducers 0..10 V / 4..20 mA have a standard setting at an operating voltage of 24 V =. That means, that at this voltage, the expected measuring error of the output signal will be the least. For other operating voltages, the offset error will be increased by a changing power loss of the sensor electronics. If a re-calibration should become necessary later directly on the sensor, this can be done by means of a trimming potentiometer on the sensor board.

Remark: Occurring draft leads to a better carrying-off of dissipative power at the sensor. Thus temporally limited fluctuations might occur upon temperature measurement.

» APPLICATION NOTICE FOR HUMIDITY SENSORS

Refrain from touching the sensitive humidity sensor/element. Touching the sensitive surface will void warranty.

For standard environmental conditions re-calibration is recommended once a year to maintain the specified accuracy.

When exposed to high ambient temperature and/or high levels of humidity or presence of aggressive gases (i.e. chlorine, ozone, and ammonia) the sensor element may be affected and re-calibration may be required sooner than specified. Re-calibration and deterioration of the humidity sensor due to environmental conditions are not subject of the general warranty.

» **TECHNICAL DATA**

Measuring values (type-dependent)	temperature, humidity
Output Voltage (type-dependent)	AO2V 2x 0..10 V, heating & cooling, (min. load 10 kΩ)
	OVR OVT 1x 0..10 V cooling, (min. load 10 kΩ)
Output switching contact (type-dependent)	DO2R 2x floating contact NO for 24 V =/~, load max. 3 A, heating & cooling
	OVR 1x floating contact NO for 24 V =/~, load max. 3 A, heating
	OVT 1x floating contact Triac for 24 V ~, load max. 1 A, cooling
	DO2T 2x floating contact Triac for 24 V ~, load max. 1 A, heating & cooling
Network technology	RS485 BACnet MS/TP
Power supply	15..24 V = (±10%) or 24 V ~ (±10%) SELV
power consumption	typ. 0,9 W (24 V =) 1 VA (24 V ~)
Measuring range temperature	+32..+122 °F
Measuring range humidity	0..100% rH non-condensing
Accuracy temperature	±0,5 K (typ. at 70 °F)
Accuracy humidity	±2% between 10..90% (typ. at 70 °F)
Inputs (type-dependent)	DI4 4x inputs digital for floating contacts
Set point (P) (optional)	Potentiometer
Rocker switch (S) (optional)	for fan speed adjustment
Button (T) (optional)	for presence detection
LED (D) (optional)	for status feedback, green (standard), several LEDs possible (e.g. green, yellow, red)
Protection	IP20 according to EN 60529
Connection electrical	terminal block, max. AWG16
Ambient condition	+32..+122 °F, max. 85% rH non-condensing
Mounting	flush mounted in standard EU box (Ø=2.36in. 60 mm, min. depth=1.77in. 45 mm), DO2T, DO2R, OVR, OVT with IO extension need 2 flush-mounting boxes (Ø=2.36in. 60 mm) and double frame (alternatively, the IO unit can be mounted in a deep flush-mounted box or be detached up to 10 m)
Notes	for further variants see chapter room operating units, for other operating elements please request, for other frame designs please request

» **PRODUCT TESTING AND CERTIFICATION****Declaration of conformity**

The declaration of conformity of the products can be found on our website <https://www.thermokon.de/>.

» TYPE OVERVIEW - FUNCTIONALITY

WRF07	Digital Inputs	Internal Controller	0..10 V Heating	0..10 V Cooling	Relay Heating	Relay Cooling	Triac Heating	Triac Cooling	6WV Heating&Cooling
DI4	4								
AO2V	2	•	•	•					•
OVR	2	•		•	•				
OVT	2	•		•	•				
DO2R	2	•			•	•			
DO2T	2	•					•	•	

» CONNECTION PLAN

WRF07 x (rH) DI4

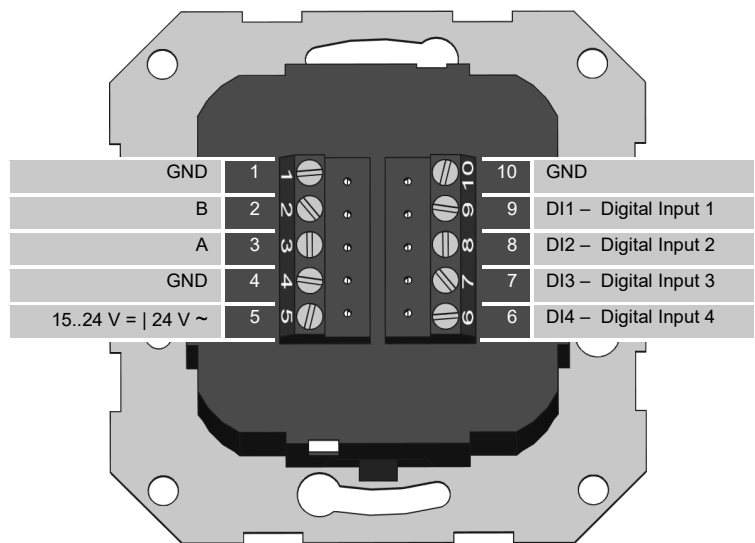
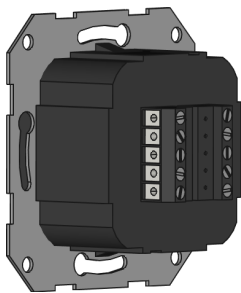

WRF07 x (rH) AO2V

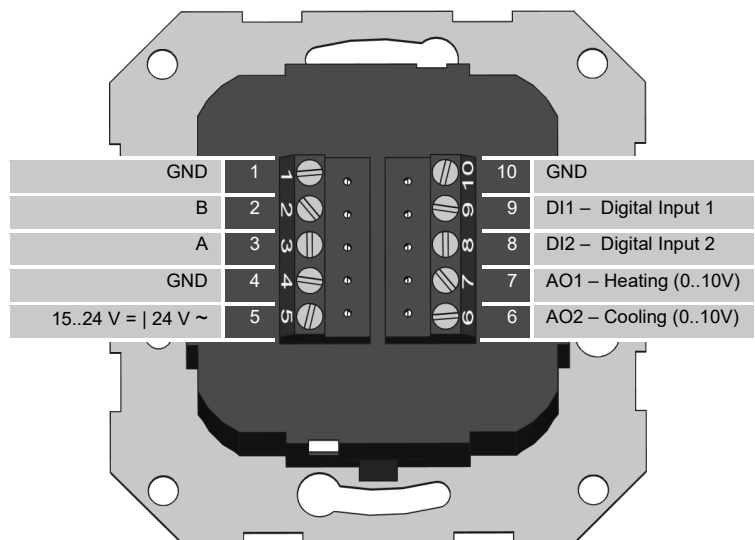
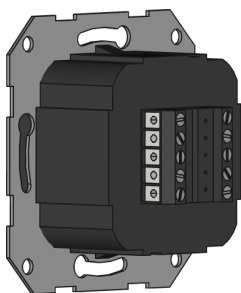

WRF07 x (rH)

DO2R IO-module

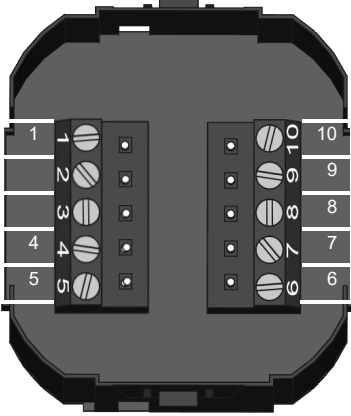
DI2 – digital input 2	1	10	GND
	2	9	DI1 – digital input 1
	3	8	max. 24 V (DO1 DO2)
GND	4	7	DO1 – heating (relay)
15..24 V = 24 V ~	5	6	DO2 – cooling (relay)

DO2T IO-module

DI2 – digital input 2	1	10	GND
	2	9	DI1 – digital input 1
	3	8	GND (DO1 DO2)
GND	4	7	DO1 – heating (Triac)
15..24 V = 24 V ~	5	6	DO2 – cooling (Triac)

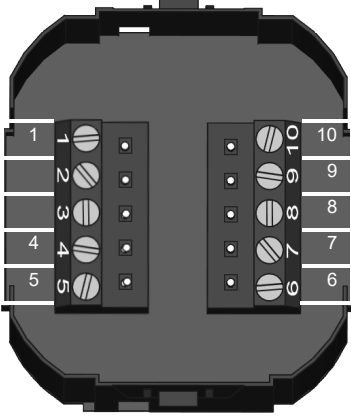
OVR IO-module

DI2 – digital input 2	1	10	GND
	2	9	DI1 – digital input 1
	3	8	max. 24 V (DO1)
GND	4	7	DO1 – heating (relay)
15..24 V = 24 V ~	5	6	AO2 – cooling (0..10V)

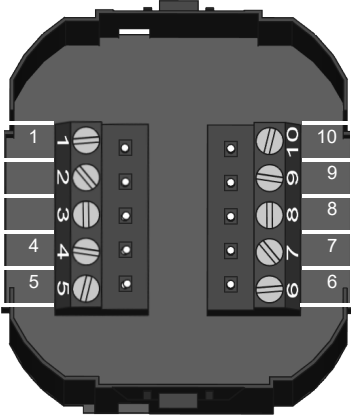
OVT IO-module

DI2 – digital input 2	1	10	GND
	2	9	DI1 – digital input 1
	3	8	GND (DO1 DO2)
GND	4	7	DO1 – heating (Triac)
15..24 V = 24 V ~	5	6	AO2 – cooling (0..10V)

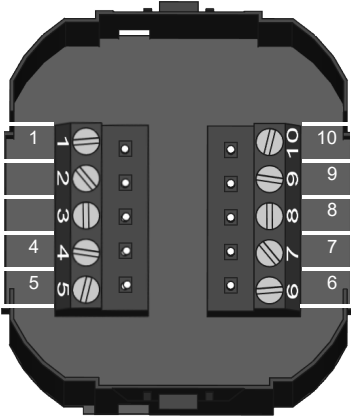
» **DIP SWITCH CONFIGURATION / TERMINATION**

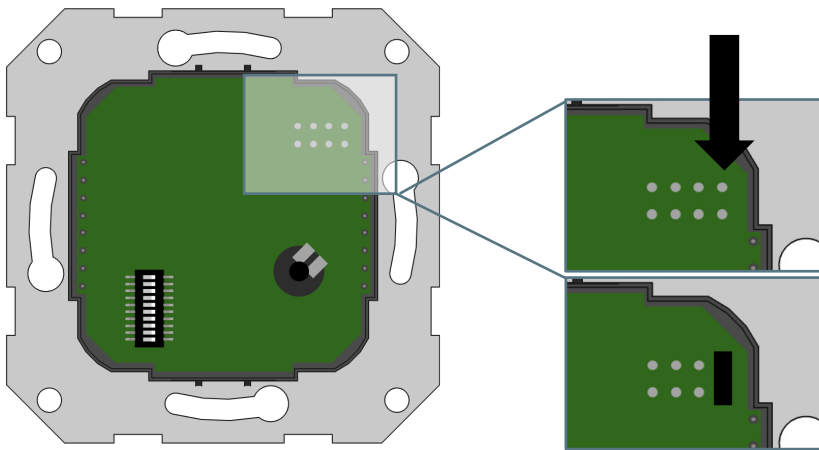

Don't forget the BUS termination (**120 Ω**) at the last device of the line!

Jumper not set:
Termination not active

Jumper set:
Termination active

Modbus-address - DIP 1..7 (binary coded)

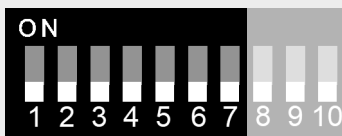

DIP switch	1 = on	2 = on	3 = on	4 = on	5 = on	6 = on	7 = on
Value	2 ⁰ (1)	2 ¹ (2)	2 ² (4)	2 ³ (8)	2 ⁴ (16)	2 ⁵ (32)	2 ⁶ (64)

Baud rate - DIP 8..9

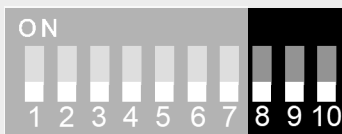

8	9	10	Baud rate
off	off	off	9600
on	off	off	19200
off	on	off	38400
on	on	off	57600
off	off	on	76800
on	off	on	115200
off	on	on	
on	on	on	

Via the integrated LEDs the current operating status of the Modbus interface is indicated.

LED	Colour	Description
STA	Green	Lights up permanently during normal operation
RXD	Yellow	Blinks when RS485 Modbus telegrams are received
TXD	Yellow	Blinks when RS485 Modbus telegrams are sent
ERR	Red	Lights up in case of a corrupt bus configuration and internal errors

Note: During startup, all 4 LEDs blink for a few seconds.

» **CONFIGURATION SOFTWARE AND PROTOCOL DESCRIPTION**



BACnet Objects / BIBBs and PICS:
RS485 BACnet MS/TP Interface

A detailed description of the BACnet interface can be found under the following link:
→ [Download](#)

» MOUNTING ADVICES

The device is designed for mounting on a flush-mounted box. The bus cable is connected to the device by a terminal screw. For pre-wiring, the clamping screw can be removed. Due to the space for cabling, the use of deep installation boxes is recommended. The screws of the installation box (maximum torque of the screws 0.8 Nm) can fasten the lower part. The installation must be carried out in representative places for the room temperature, in order to avoid a falsification of the measuring result. Direct sunlight and drafts should be avoided. The end of the installation pipe in the flush-mounted box must be sealed in order to prevent drafts in the pipe. To ensure a smooth and accurate installation, it is essential that the installation boxes used are not jut out from the wall surface. The box must be flush with the wall or slightly recessed in the wall.

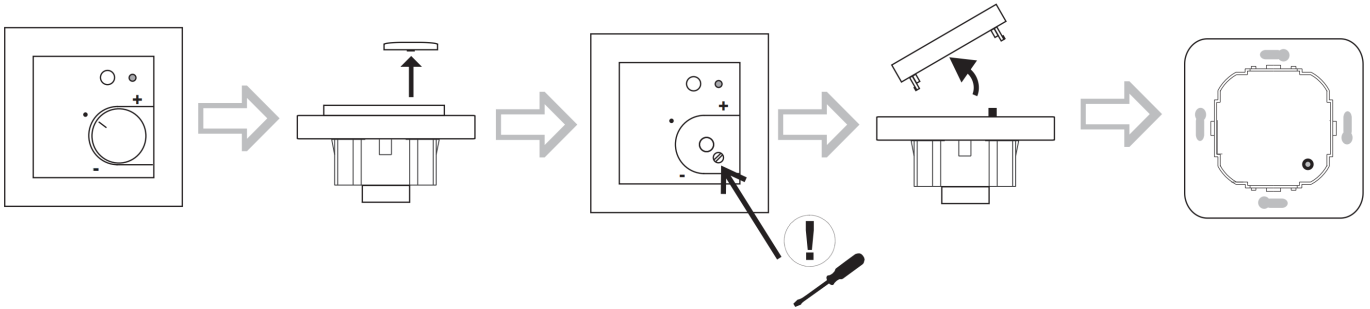

» DIMENSIONS (IN)

Outside dimensions are depending on the frame of the respective switch range.

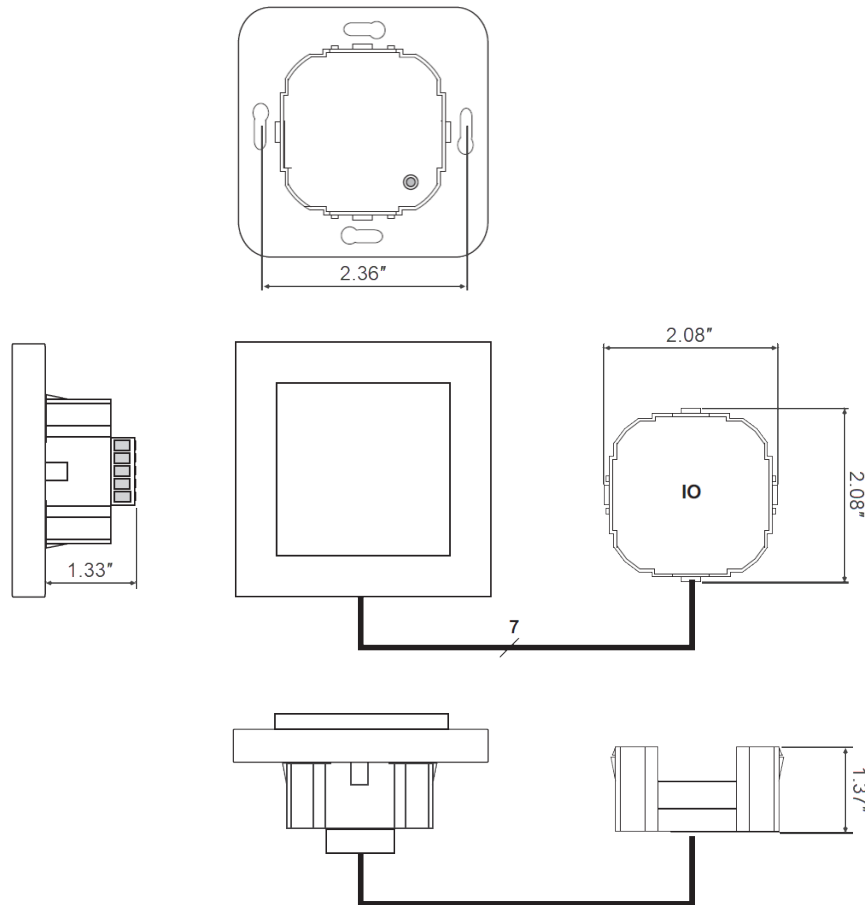

» ACCESSORIES (OPTIONAL)

PSU-UP24 – flush mount power supply 24 V (AC Input 80..240 V ~ DC Output 24 V = 0,5 A)

Item No. 668293